

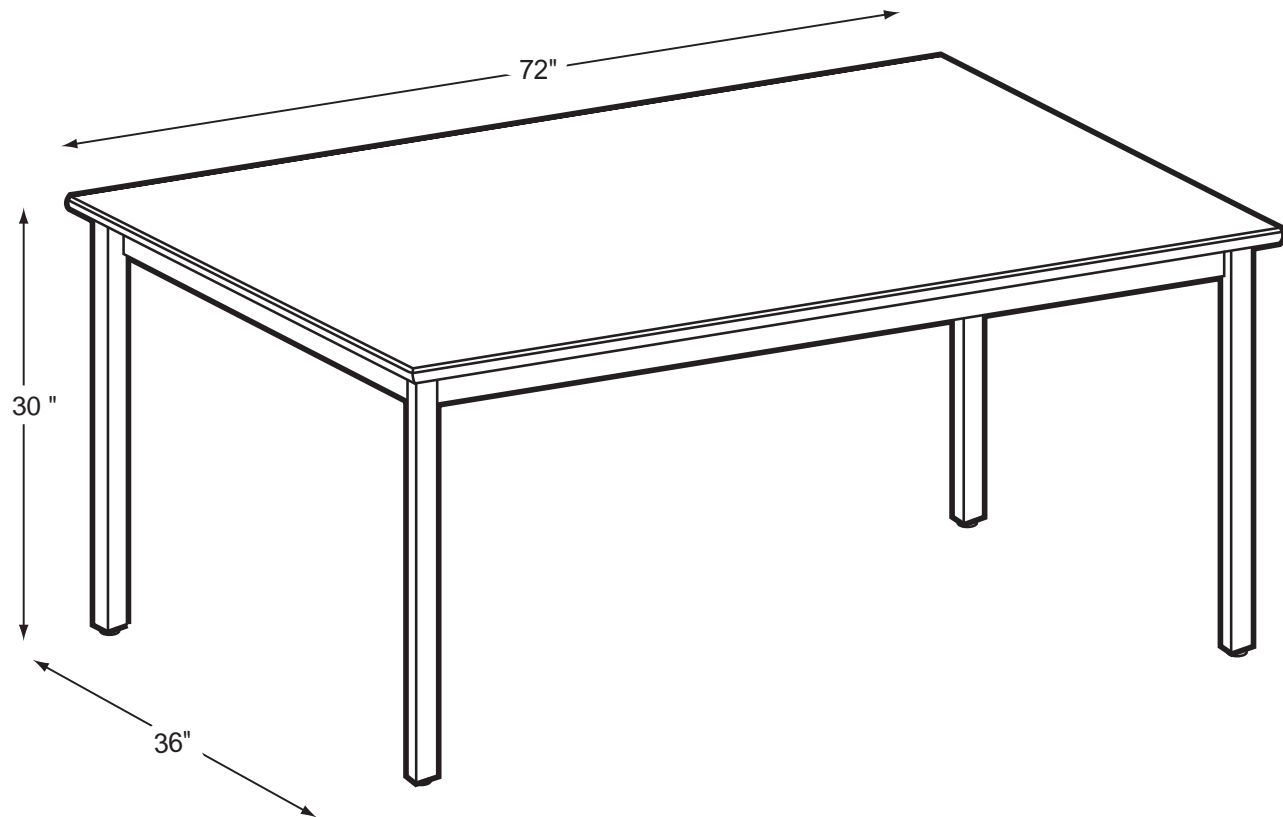

3672-wf

Welded Frame Table



Product Specs

- Fully welded unitized frame
- 1" x 2" 16 ga. Tubing on perimeter skirts
- 1-1/4" x 1-1/4" 16 ga. Tubing on legs
- 16 ga. Welded top attachment brackets
- Steel cleaned with Biodegradable solution with phosphatizing coat
- Powder Coat finish
- 1/4-20 Threaded inserts on each leg
- 1-1/8" case hardened rubber cushion glides
- #10-3/4" Auger point, steep-pitched top attachment screws

0209