

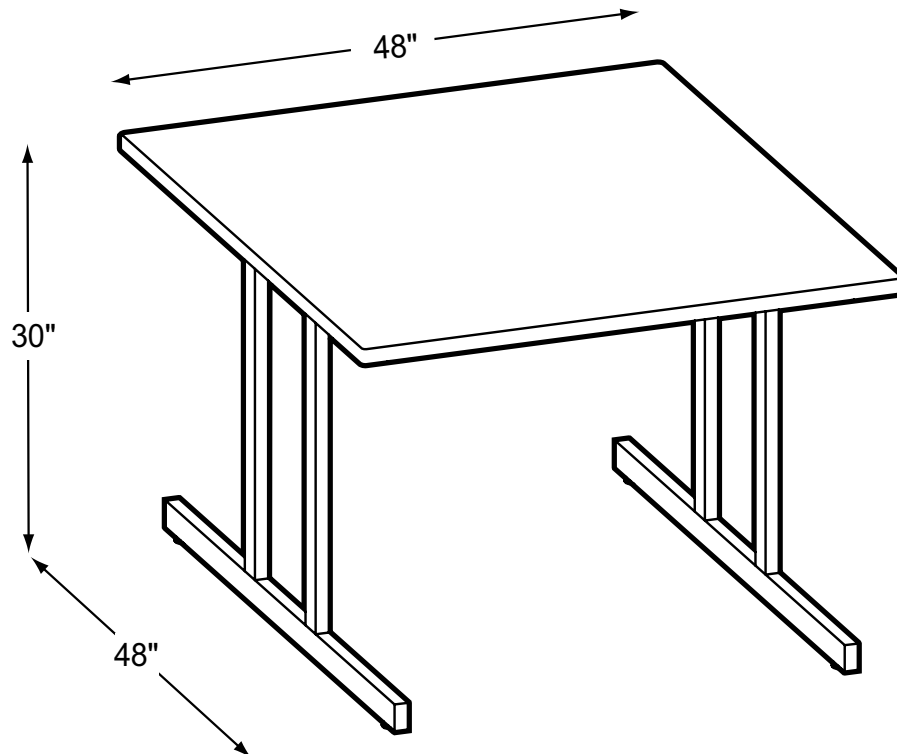

48S-SPB

Single Pedestal Base Table



Product Specs

- Fully welded unitized base
- 1" x 2" 16 ga. tubing on foot, upright and spanner
- 1" x 1" 10 ga. angle iron on top support
- 1-1/2" x 1-1/2" 10 ga. angle iron additional top spanner on tops over 60
- Steel cleaned with biodegradable solution with phosphatizing coat
- Powder coat finish
- 4 - 1" x 2" locking caps with 1/4 20 threaded inserts (2 per leg)
- 1-1/8" case hardened rubber cushion glides
- #10-3/4" auger point, steep pitched top attachment screws