

PA6032-39

Patron Access Stations

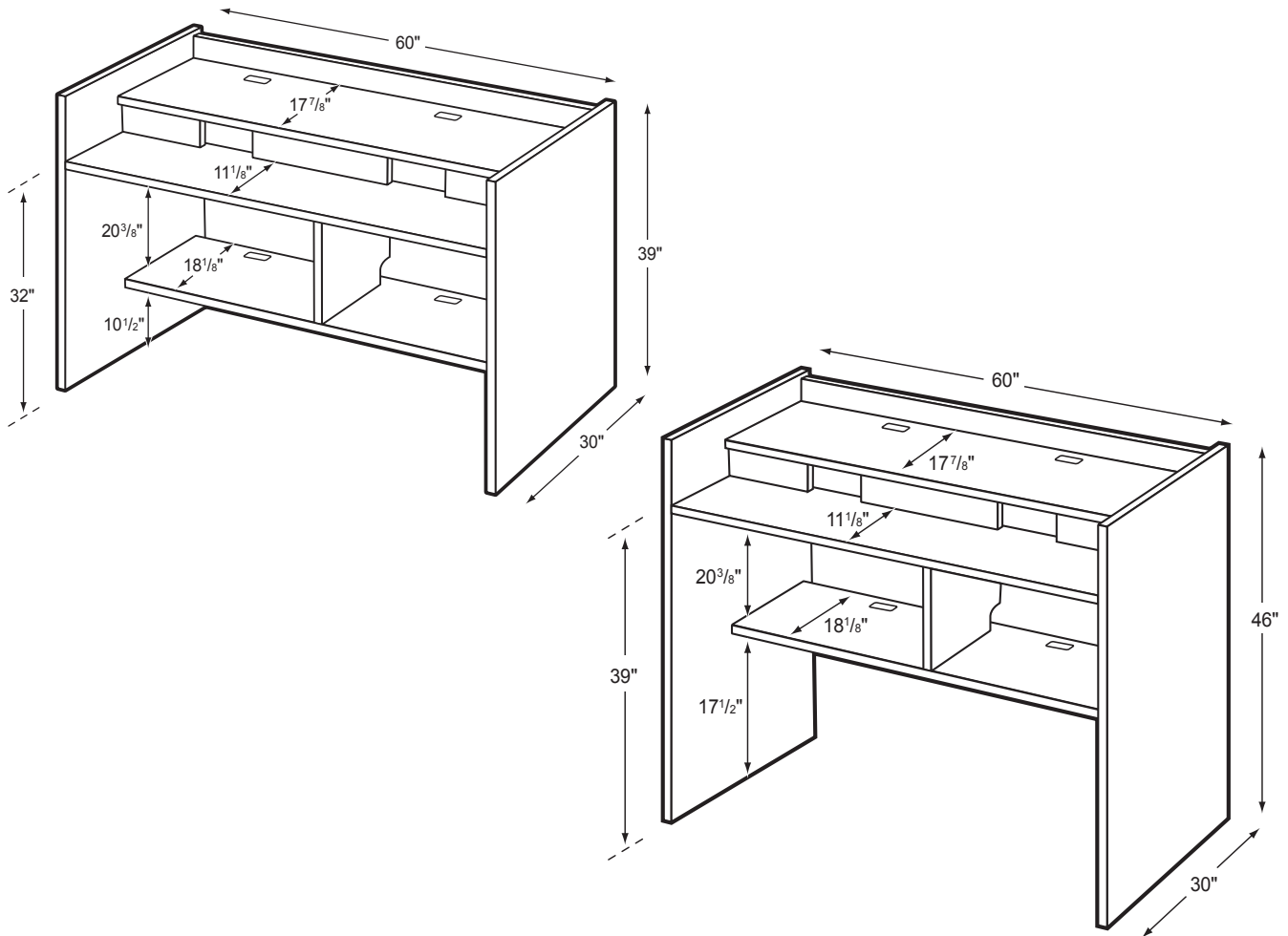

Product Specs

- 1" thermal fused laminate sides
- 3/4" thermal fused laminate top, keyboard, fixed shelf and back
- Cam and post construction
- Matched edge banding
- Fixed split level keyboard and monitor shelf
- Fixed storage shelf
- Two - 2"x 4" grommets with covers
- Adjustable leveling glides

0208