



BY  **IRONWOOD**

LIBRARY SHELVING UNIT

**LS42SB LS48SB
LS60SB LS72SB
LS84SB**

**SINGLE
BASE UNIT**

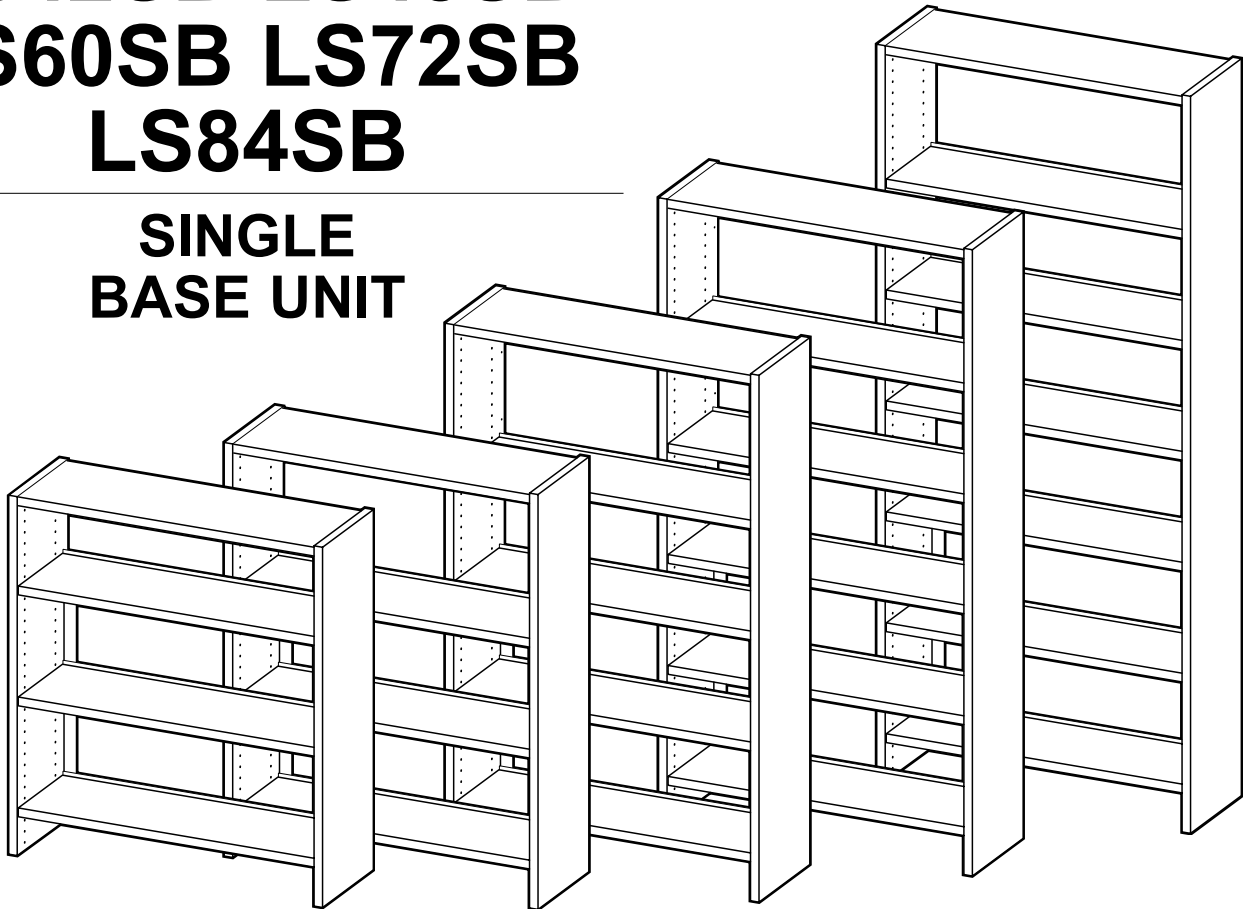

IMPORTANT!

Assembly may require the assistance of another person.

Before you begin assembly:

READ THE DIRECTIONS all the way through one time. This will speed up the process and help you understand the sequence of steps.

COUNT THE PARTS AND HARDWARE before assembly. This ensures you have received all necessary parts before you begin.

TOOLS: You may need a Phillips head screwdriver, a medium slotted screwdriver or a plastic mallet. To protect your new furniture from damage during assembly, it is recommended to work on a carpeted surface.

Thank you for purchasing Ironwood Shelving. Please consult your local building codes when installing shelving. It is recommended that all single face shelving be attached to the wall, while double face shelving over 60" in height should be attached to the floor. These are guide lines and vary from state to state.

In the event any parts are missing from this package, send your name, address, telephone number, and a description of the missing part(s) to: **PARTS, Box 1420, Missoula, MT 59806** or call: **1-800-769-5693** or **FAX 1-800-445-5281**.

CAUTION: On assemblies requiring glue, make sure the unit is assembled correctly before gluing. Once this unit is assembled with glue, the manufacturer will not be responsible for damaged parts. Keep a damp cloth or sponge handy to wipe off excess glue.

To care for this furniture, simply wipe with a cloth dampened with glass cleaner containing ammonia-D.

PARTS DIAGRAM

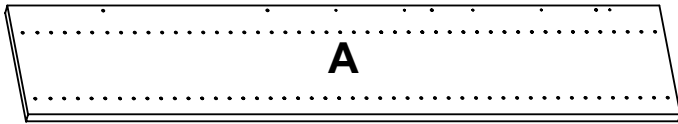

Left Side - LS42SB	01200141	1 ea.
Left Side - LS48SB		1 ea.
Left Side - LS60SB		1 ea.
Left Side - LS72SB		1 ea.
Left Side - LS84SB		1 ea.

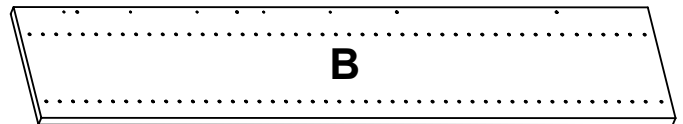

Right Side - LS42SB	01200141	1 ea.
Right Side - LS48SB		1 ea.
Right Side - LS60SB		1 ea.
Right Side - LS72SB		1 ea.
Right Side - LS84SB		1 ea.

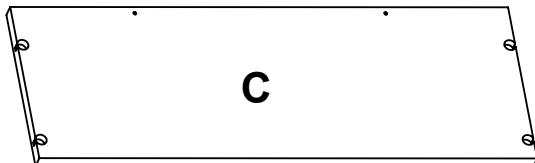

Top	01200101	1 ea.
-----	----------	-------

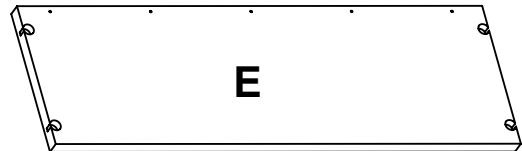

Fixed/ Adjustable Shelf	LS42SB	01200124	3 ea.
	LS48SB		3 ea.
	LS60SB		4 ea.
	LS72SB		5 ea.
	LS84SB		6 ea.

HARDWARE



H1	Rafix Cam	909909	LS42SB - 8 ea. LS48SB - 8 ea. LS60SB - 8 ea. LS72SB - 8 ea. LS84SB - 8 ea.
----	-----------	--------	--

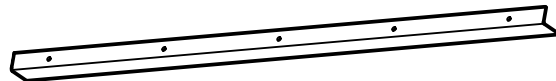

H2	Book Stop	412226	LS42SB - 3 ea. LS48SB - 3 ea. LS60SB - 4 ea. LS72SB - 5 ea. LS84SB - 6 ea.
----	-----------	--------	--



H3	# 8 x 5/8" Panhead Screw	988056	LS42SB - 25 ea. LS48SB - 25 ea. LS60SB - 30 ea. LS72SB - 35 ea. LS84SB - 40 ea.
----	--------------------------------	--------	---



H4	Rafix Bolt	909923	8 ea.
----	------------	--------	-------

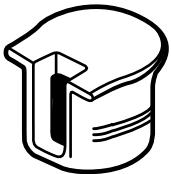

H5	Rafix Shelf Cam	909912	LS42SB - 8 ea. LS48SB - 8 ea. LS60SB - 12 ea. LS72SB - 16 ea. LS84SB - 20 ea.
----	--------------------	--------	---



H6	Rafix Shelf Pin	909924	LS42SB - 7 ea. LS48SB - 7 ea. LS60SB - 12 ea. LS72SB - 16 ea. LS84SB - 20 ea.
----	--------------------	--------	---

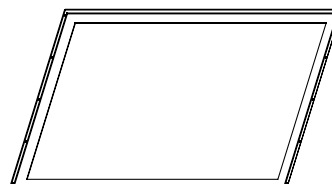

H7	Metal Frame	412026	1 ea.
----	-------------	--------	-------

**If you have purchased an Adder unit
to be assembled in conjunction with this Base unit,**

it is important to read all the way through the Adder instructions (enclosed in the Adder carton) before beginning. It will be necessary to substitute a Divider (J) for a Right Side (B) during assembly.

**If you have purchased the Back option or the Toe Space option
to be assembled in conjunction with this Base unit,**

it is important to read through the Back option and/or Toe Space option directions before beginning.

NOTE:

**The diagrams show one size for ease of viewing.
Any differences will be indicated in each step's text.**

Using the Rafx System:

Insert the Rafx Cams into the appropriate holes. The flat edge of the cam should be facing the edge of the panel.

Slide Rafx Cams of the panel to be attached onto the corresponding posts.

When screwing post into hole, **Do Not** over tighten. Screw post down until bottom face of post flange just touches board surface.

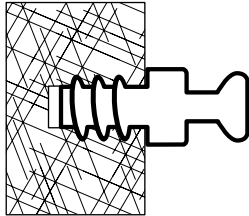

Using a #3 Phillips screwdriver, turn the rotating portion of the Rafx Cam a 1/2 turn clockwise to secure. **IMPORTANT!** Do not exceed 1/2 turn when tightening cams. Turn 1/2 turn counterclockwise to disassemble and remove panel.

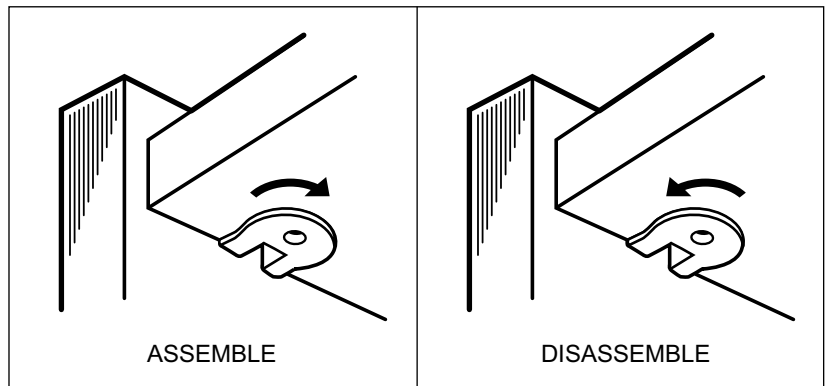
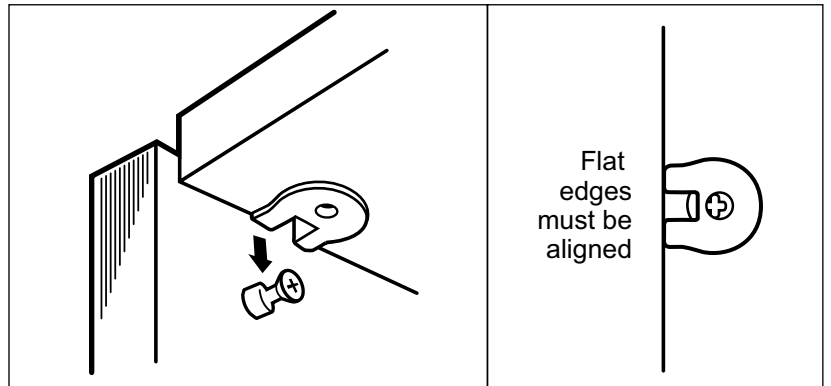

#1

Install four Rafix Shelf Cams (H5) into each adjustable shelf. Attach a Book Stop (H2) to each Fixed/Adjustable Shelf (E) using five Panhead Screws (H3) in the pre-drilled holes.

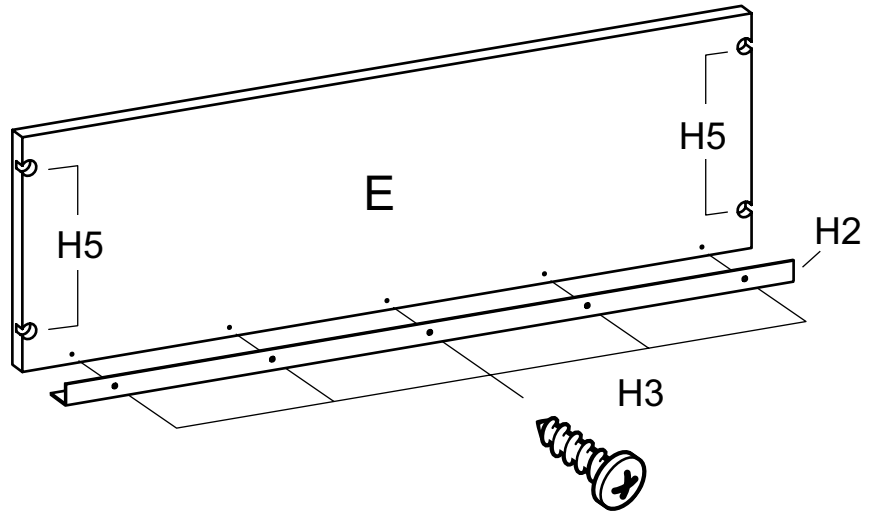

Install four Rafix Cams(H1) into each fixed shelf

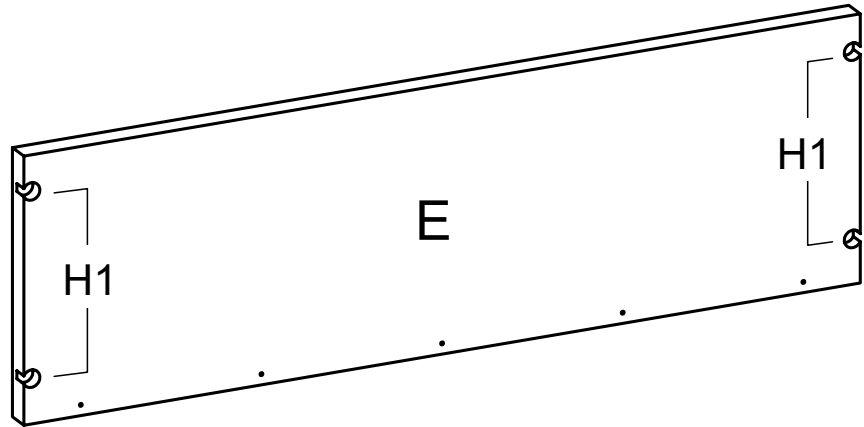

#2

Install four Rafix Cams(H1) into the Top Panel (C) as shown.

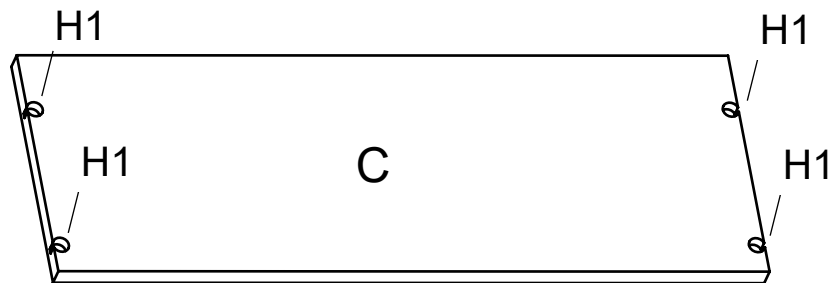

#3

Place both Sides (A & B) on a clean, carpeted surface as shown. Install Rafix Bolts(H4) in each Side Panel into the selected pre-drilled holes as indicated.

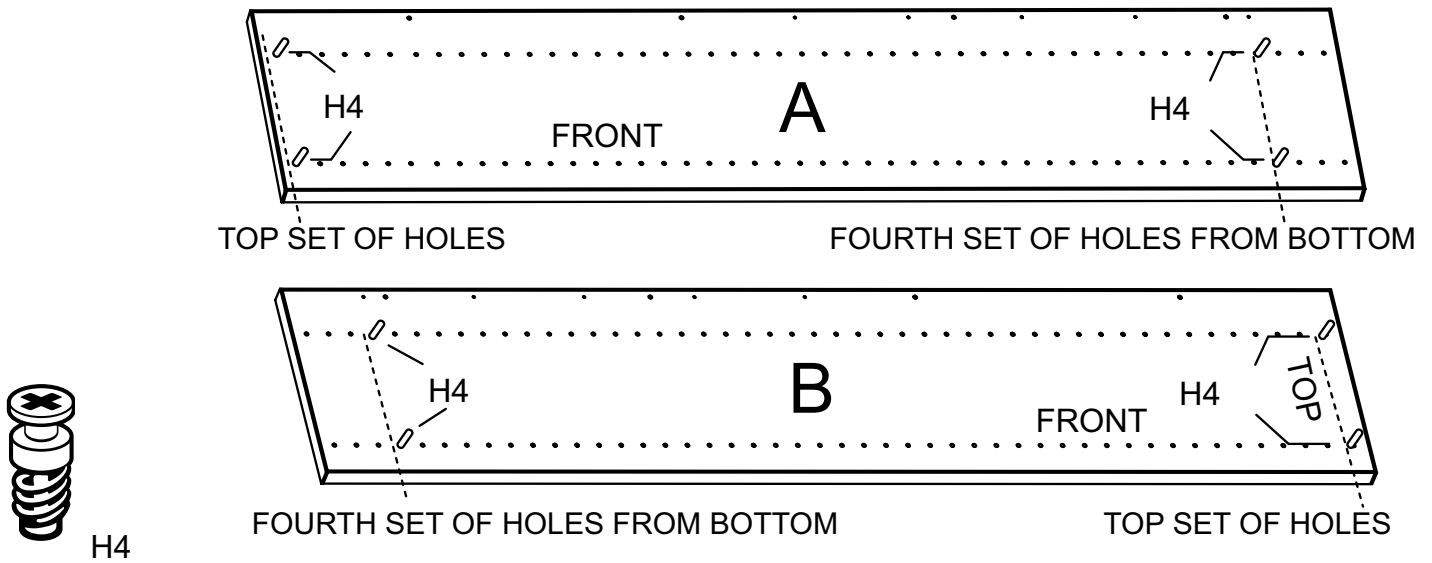

#4

Attach a Metal Frame (H6) or Back Panel (D).

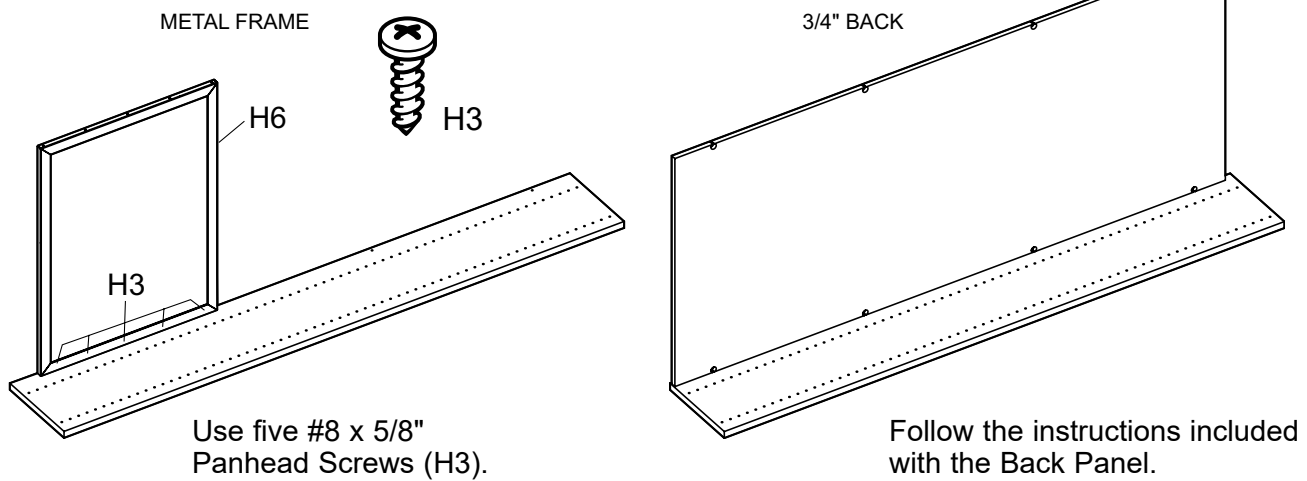

NOTE: If you are installing an Adder, follow the instructions for an Adder unit at this time.

#5

With the assistance of another person, stand the assembly upright and install the other side panel (B).

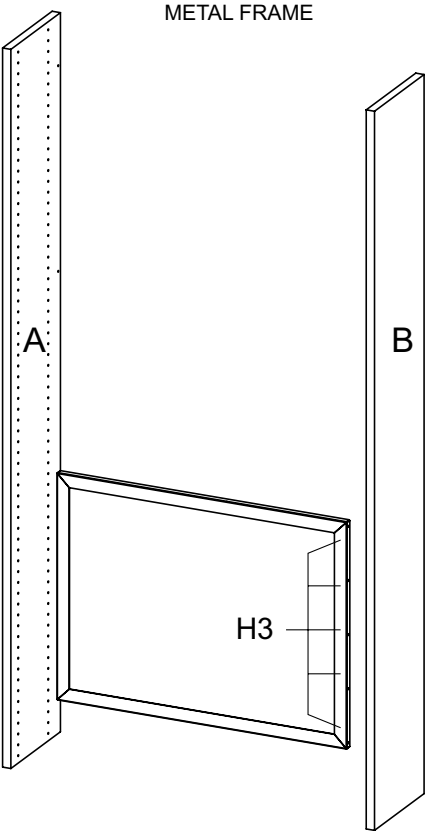

Use five #8 x 5/8" Panhead Screws.

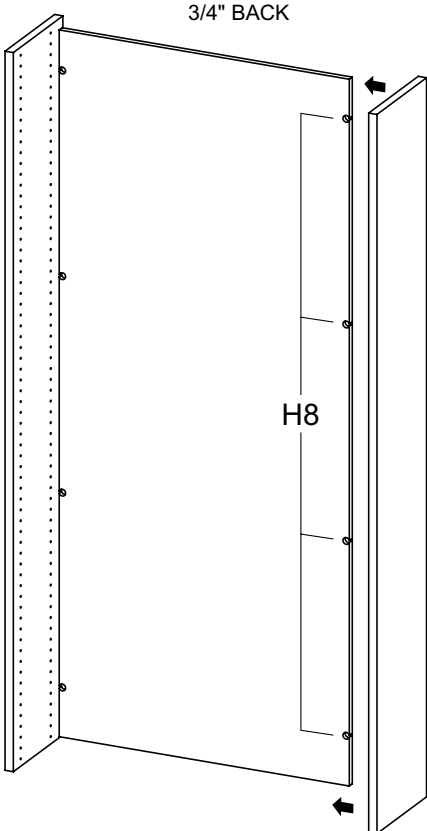

Turn Rafx Cams (H8) 1/2 turn clockwise to tighten.

NOTE: If you are installing the Toe Space option, it is recommended to install the Toe Space at this time. Follow the directions included with the Toe Space option.

#6

Attach the Top Panel (C) and the Fixed Shelf (E) using the Rafx system. Turn the Cams 1/2 turn to tighten.

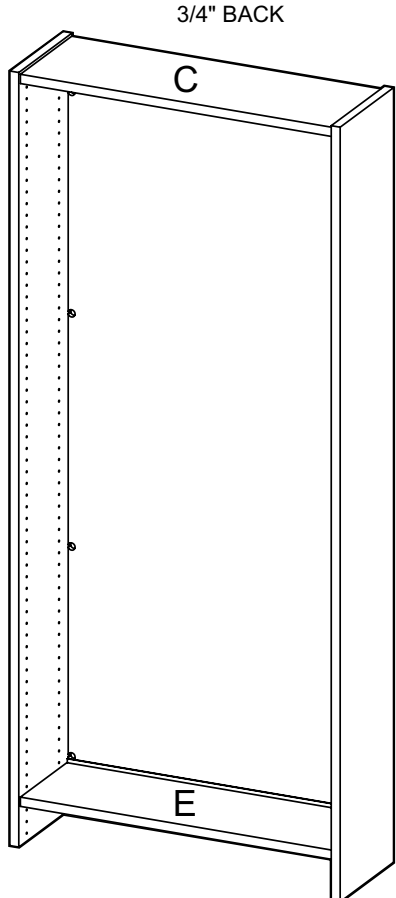
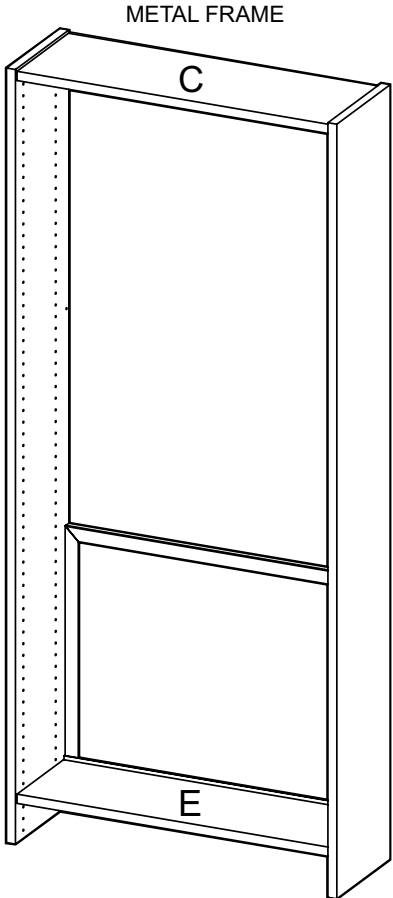

#7

Insert Rafx shelf pins (H6) at desired shelf heights. Place the Adjusting Shelves (E) in the unit.

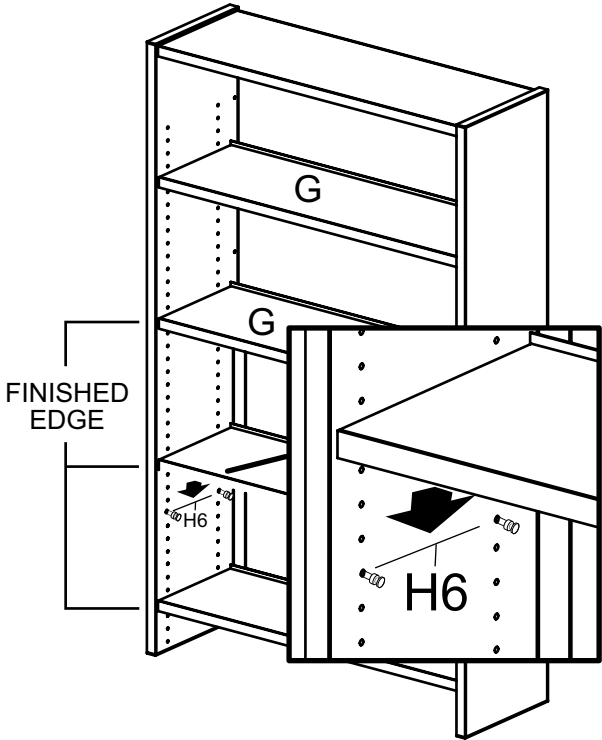

#8

Your Glacier Library Shelving Unit is now assembled and ready for use.

