

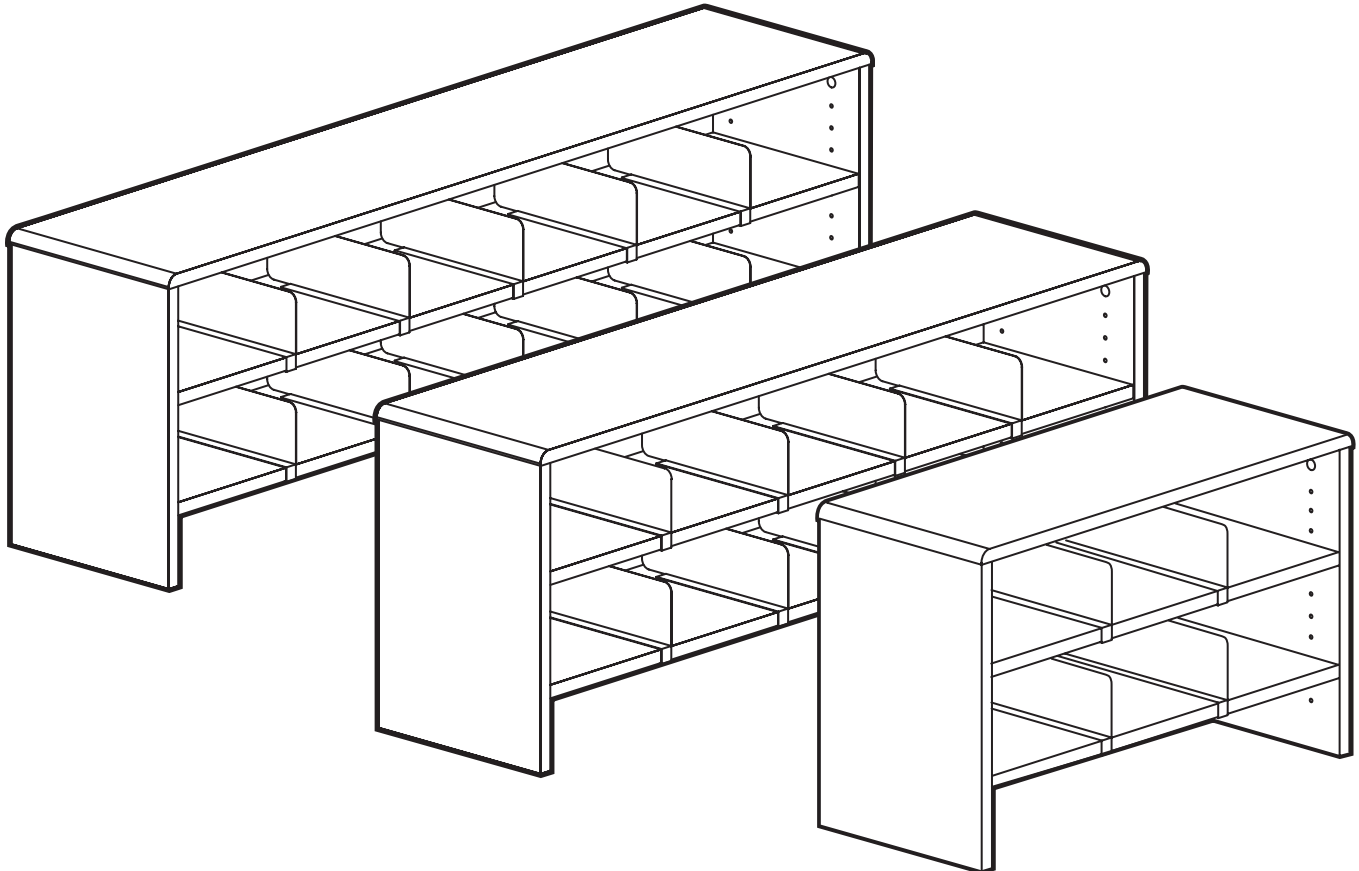

IRONWOOD

DTO29-47-56

DESKTOP ORGANIZERS



IMPORTANT!

Assembly may require the assistance of another person.

Before you begin assembly:

READ THE DIRECTIONS all the way through one time. This will speed up the process and help you understand the sequence of steps.

COUNT THE PARTS AND HARDWARE before assembly. This ensures you have received all necessary parts before you begin.

TOOLS: You may need a Phillips head screwdriver, a medium slotted screwdriver or a plastic mallet. To protect your new furniture from damage during assembly, it is recommended to work on a carpeted surface.

In the event any parts are missing from this package, send your name, address, telephone number, and a description of the missing part(s) to: **PARTS, Box 1420, Missoula, MT 59806** or call: **1-800-769-5693** or **FAX 1-800-445-5281**.

CAUTION: On assemblies requiring glue, make sure the unit is assembled correctly before gluing. Once this unit is assembled with glue, the manufacturer will not be responsible for damaged parts. Keep a damp cloth or sponge handy to wipe off excess glue.

To care for this furniture, simply wipe with a cloth dampened with glass cleaner containing ammonia-D.

PARTS DIAGRAM



DTO 29 - Top	05762001	1 ea.
DTO 47 - Top	05761901	1 ea.
DTO 56 - Top	05761801	1 ea.

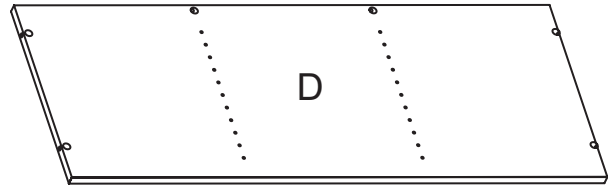

DTO 29 - Back	05762052	1 ea.
DTO 47 - Back	05761952	1 ea.
DTO 56 - Back	05761852	1 ea.



DTO 29 - Adjustable Shelf	05762024	2 ea.
DTO 47 - Adjustable Shelf	05761924	2 ea.
DTO 56 - Adjustable Shelf	05761824	2 ea.

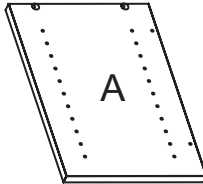

Left Side	05762042	1 ea.
-----------	----------	-------

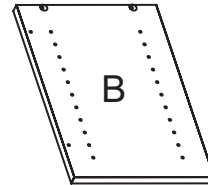

Right Side	05762042	1 ea.
------------	----------	-------

HARDWARE



H1	DTO 29 - Rafx Flush Cam	909911	08 ea.
	DTO 47 - Rafx Flush Cam	909911	10 ea.
	DTO 56 - Rafx Flush Cam	909911	11 ea.



H2	DTO 29 - Rafx Bolt	909925	8 ea.
	DTO 47 - Rafx Bolt	909925	10 ea.
	DTO 56 - Rafx Bolt	909925	11 ea.



H4	DTO 29 - Rafx Cam	909910	8 ea.
	DTO 47 - Rafx Cam	909910	12 ea.
	DTO 56 - Rafx Cam	909910	12 ea.



H5	DTO 29 - Rafx Shelf Pin	909924	8 ea.
	DTO 47 - Rafx Shelf Pin	909924	12 ea.
	DTO 56 - Rafx Shelf Pin	909924	12 ea.

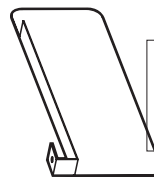

H6	DTO 29 - Shelf Divider	H10100	4 ea.
	DTO 47 - Shelf Divider	H10100	8 ea.
	DTO 56 - Shelf Divider	H10100	10 ea.

Using the Rafix System:

Insert the Rafix Cams into the appropriate holes. The flat edge of the cam should be facing the edge of the panel.

Slide Rafix Cams of the panel to be attached onto the corresponding posts.

When screwing post into hole, **Do Not** over tighten. Screw post down until bottom face of post flange just touches board surface.

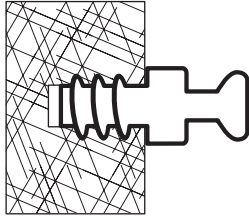

Using a #3 Phillips screwdriver, turn the rotating portion of the Rafix Cam a 1/2 turn clockwise to secure. **IMPORTANT!** Do not exceed 1/2 turn when tightening cams. Turn 1/2 turn counterclockwise to disassemble and remove panel.

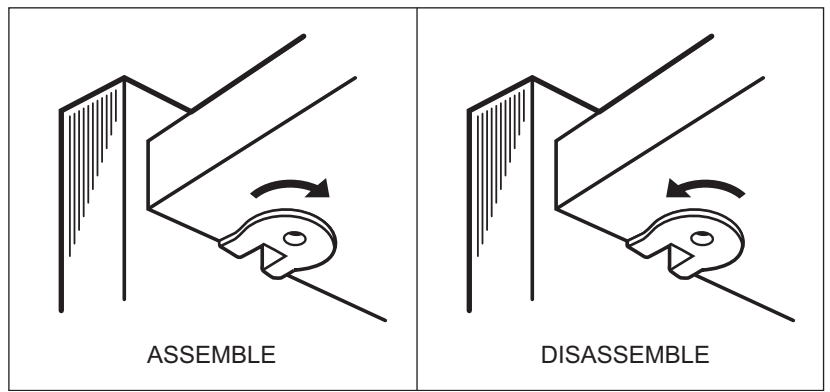
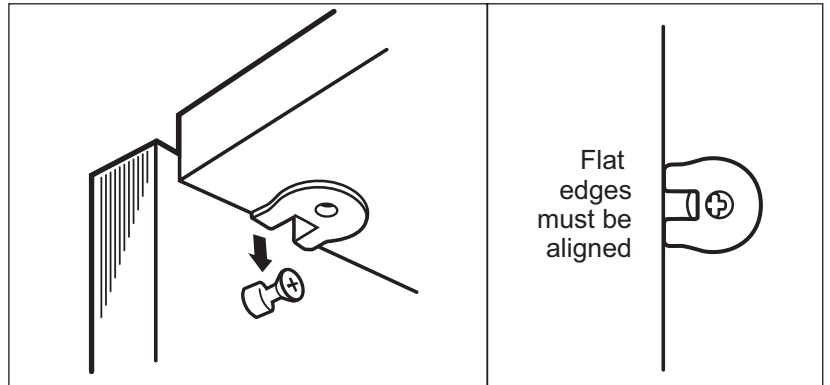

#1

Insert 2 Rafix Flush Cams (H1) into each Side (A & B). Screw in 2 Rafix Bolts (H2) on each side as shown.

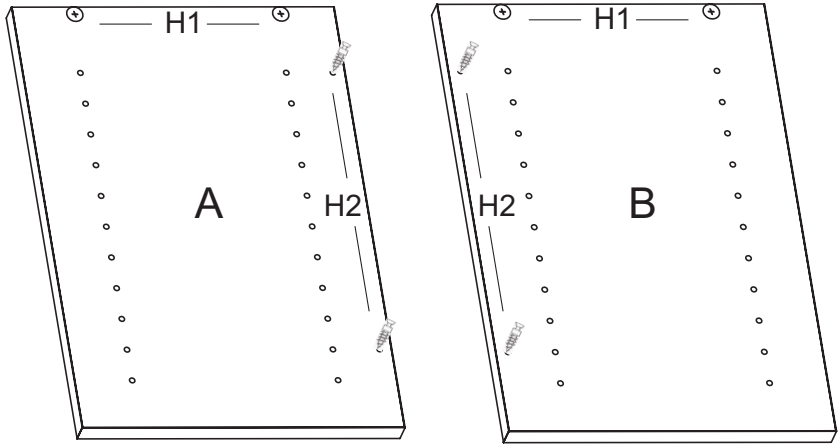

#2

Screw in 6 Rafix Bolts (H2) into Top (C) as shown in diagram.

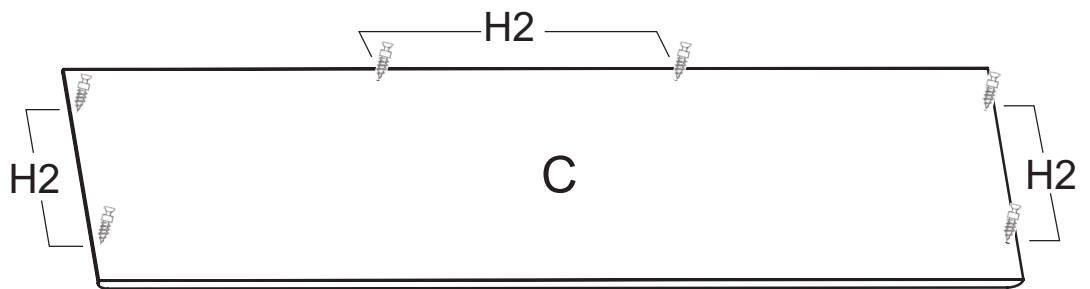

NOTE: On the DTO56 there will be 1 additional Rafix Bolt on long edge.

#3

Insert 6 Rafix Flush Cams (H1) into Bac (D).

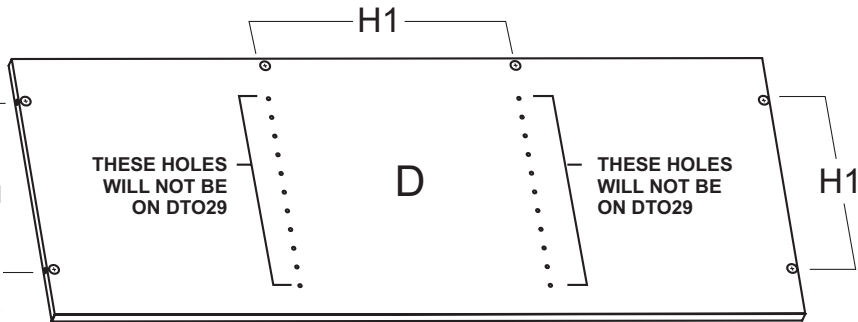

NOTE: On the DTO56 there will be 1 additional Rafix Flush Cam on the top edge.

#4

Tap in 6 Rafix Cams (H4) into Each of the 2 Adjustable Shelves (G). Tap Rafix Cams until fully seated.

NOTE: Position as shown, Rafix Cams cannot be repositioned if installed incorrectly.

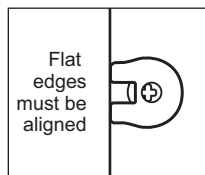

NOTE: On the DTO29 there will only be 4 Rafix Cams on each of the Shelves.

#5

Position Right Side (B) onto Back (D) as shown. Turn Rafix Flush Cams (H1) to secure.

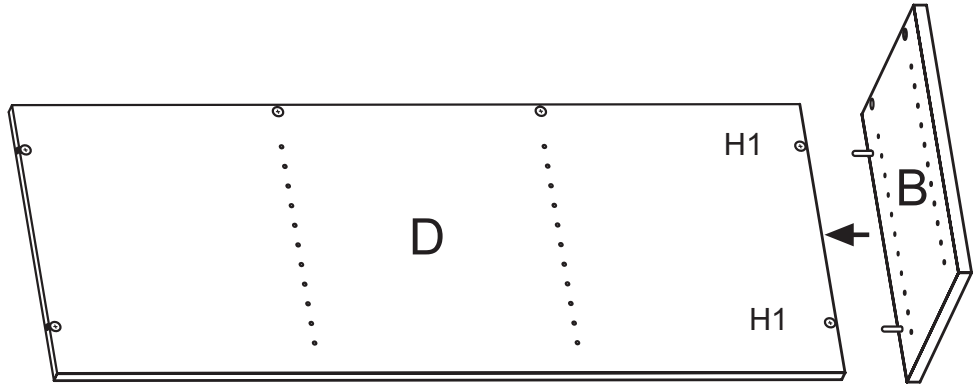

#6

Position Left Side (A) onto Back (D) and turn Rafix Flush Cams (H1) to secure.

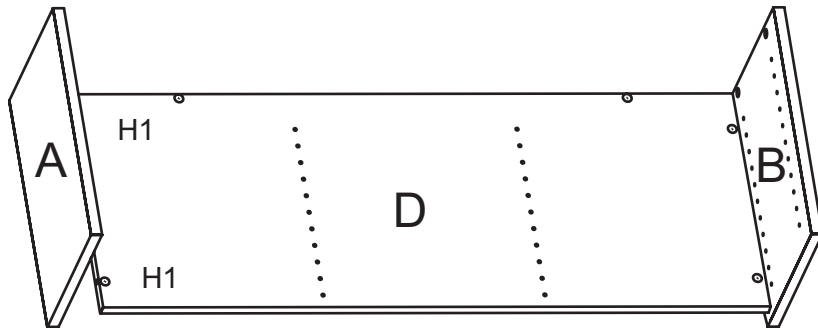

#7

Position Top C onto Sides (A & B) and Back (D) as shown and turn the Rafix Flush Cams (H1) to secure

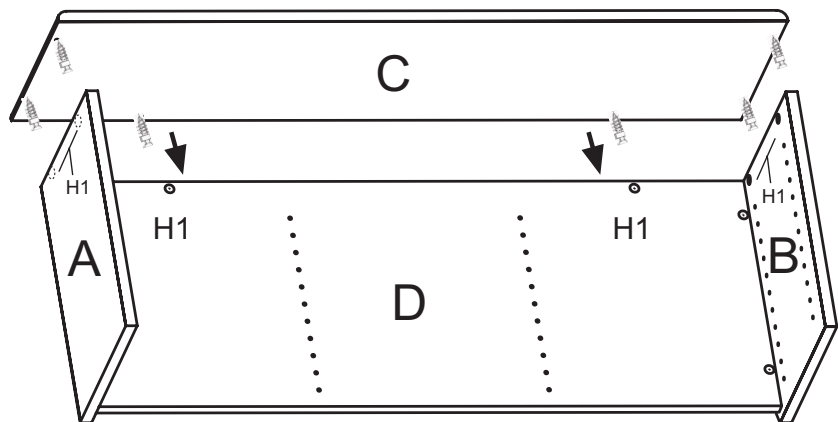

#8

Select the position for each of the 2 Adjustable Shelves (G). Push in 2 shelf pins (H5) into Sides (A & B for for all dto units) and Back (D for DTO 47 and 56). Make sure the Shelf Pins are in the same position on all sides of unit for each shelf. Turn each of the Rafix Cams (H4) on the bottom of the shelves to secure.

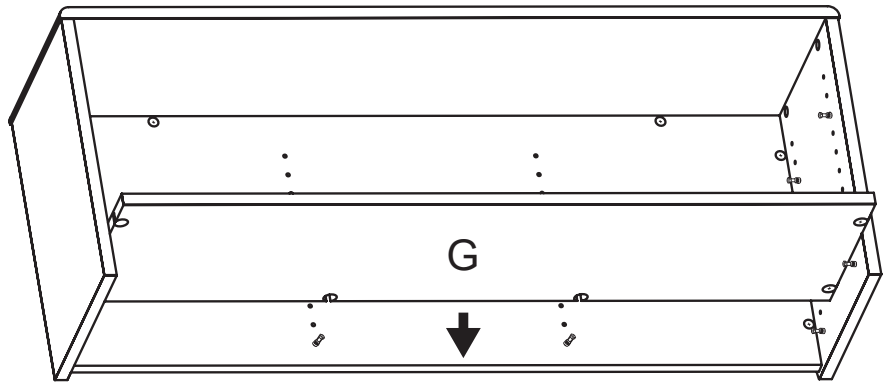

H5



#9

Slide on appropriate number of Shelf Dividers (H6) for your unit. Arrange in desired positions for your use.

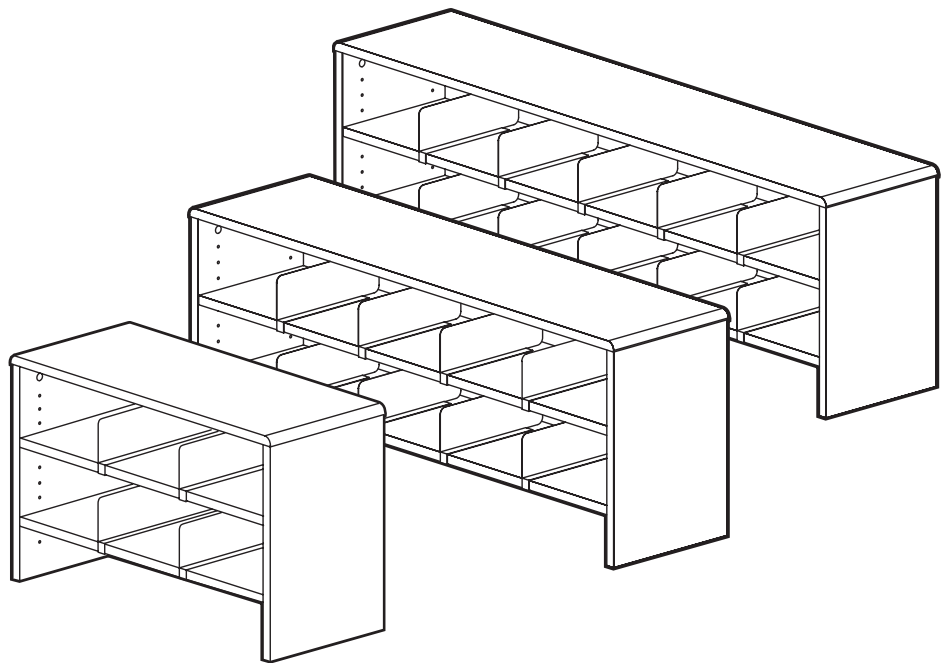

Assembly of your Desktop Organizer is now complete.