

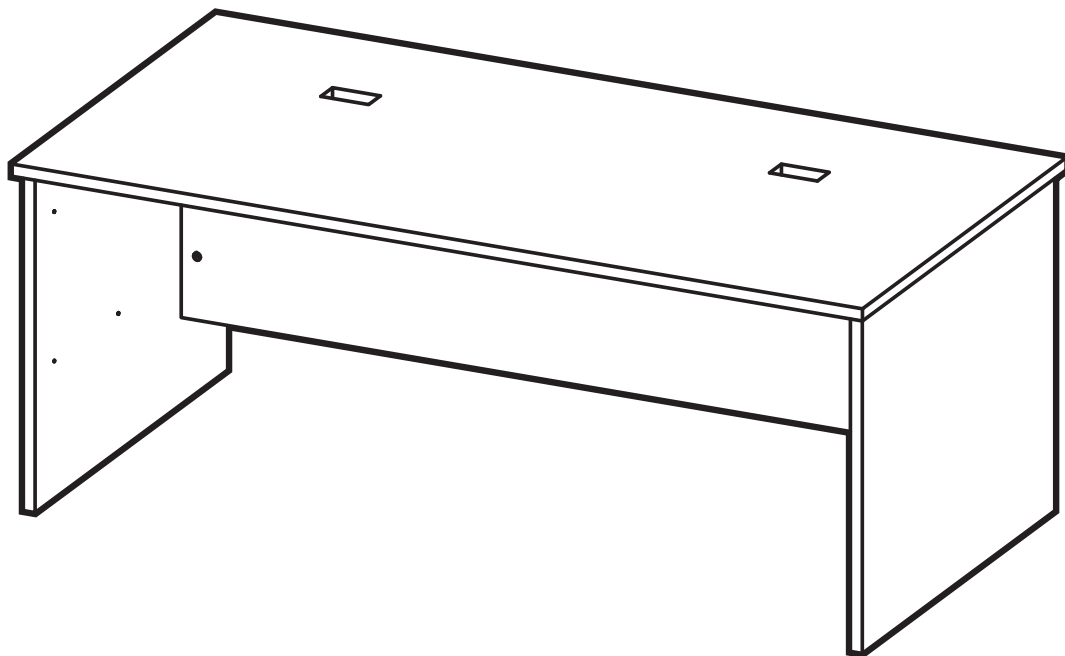

BY  **IRONWOOD**

FLD

FREESTANDING LIBRARY DESK



IMPORTANT!

Assembly may require the assistance of another person.

Before you begin assembly:

READ THE DIRECTIONS all the way through one time. This will speed up the process and help you understand the sequence of steps.

COUNT THE PARTS AND HARDWARE before assembly. This ensures you have received all necessary parts before you begin.

TOOLS: You may need a Phillips head screwdriver, a medium slotted screwdriver or a plastic mallet. To protect your new furniture from damage during assembly, it is recommended to work on a carpeted surface.

In the event any parts are missing from this package, send your name, address, telephone number, and a description of the missing part(s) to: **PARTS, Box 1420, Missoula, MT 59806** or call: **1-800-769-5693** or **FAX 1-800-445-5281**.

CAUTION: On assemblies requiring glue, make sure the unit is assembled correctly before gluing. Once this unit is assembled with glue, the manufacturer will not be responsible for damaged parts. Keep a damp cloth or sponge handy to wipe off excess glue.

To care for this furniture, simply wipe with a cloth dampened with glass cleaner containing ammonia-D.

PARTS DIAGRAM

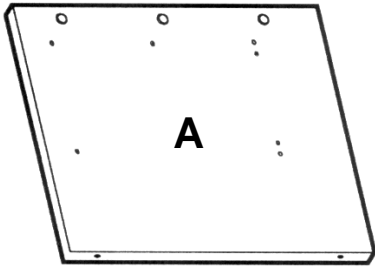

Left Side	01051141	1 ea.
-----------	----------	-------

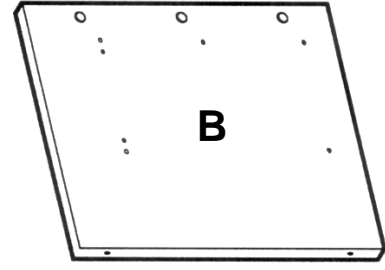

Right Side	01051141	1 ea.
------------	----------	-------

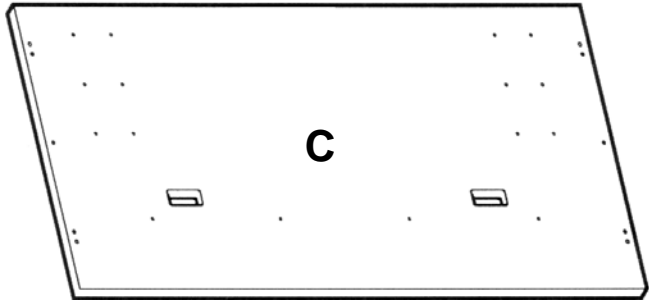

Top	01051101	1 ea.
-----	----------	-------

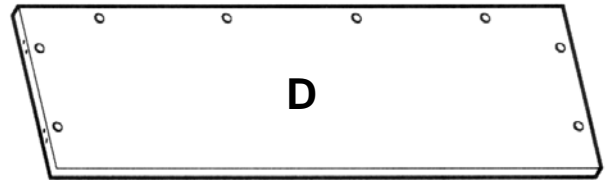

Back	01051152	1 ea.
------	----------	-------



H1	Minifix Cam	909810	14 ea.
----	-------------	--------	--------



H2	Leveler Insert	274650	4 ea.
----	----------------	--------	-------

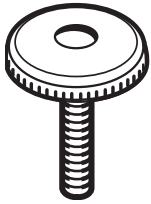

H3	Leveler	300870	4 ea.
----	---------	--------	-------



H4	Minifix Bolt	909834	14 ea.
----	--------------	--------	--------



H5	Wood Dowel	195000	8 ea.
----	------------	--------	-------

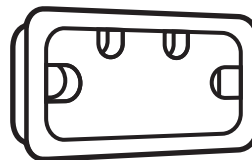

H6	Grommet	286580	2 ea.
----	---------	--------	-------

Using the Minifix System:

Insert the Minifix Cams into the appropriate holes with the arrow facing outwards as shown.

When screwing post into hole, **Do Not** over tighten. Screw post down until bottom face of post flange just touches board surface.

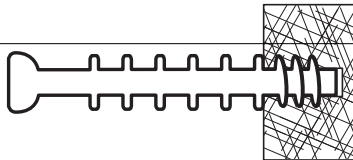
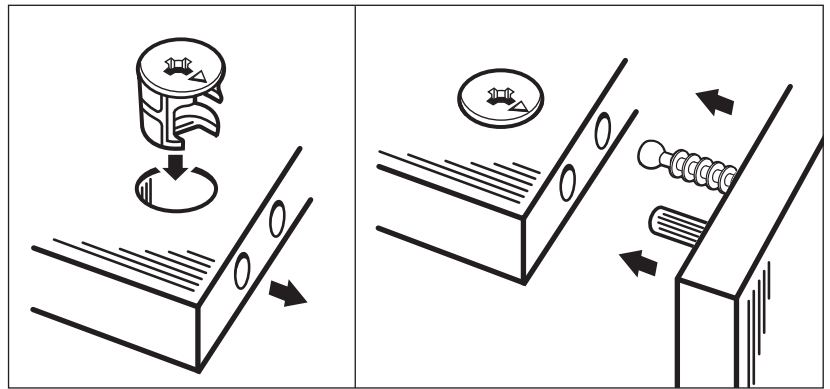

Using the #2 Phillips screwdriver, rotate the Cam Devices a half turn clockwise until snug.

To disassemble, turn the Cam Devices counter-clockwise and remove panels.

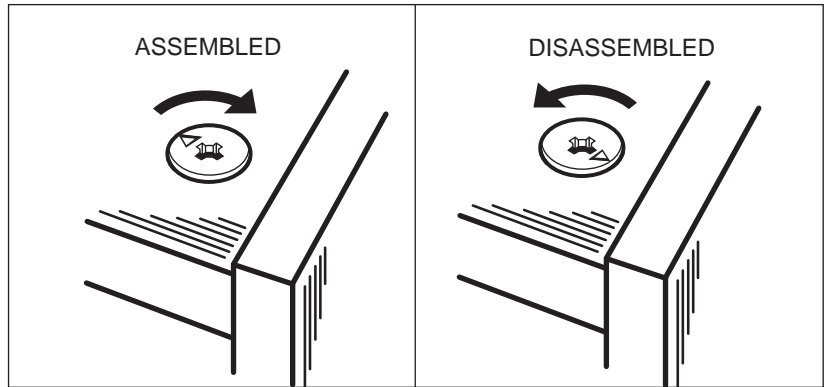

#1

Place the Back Panel (D), Left Side (A), Right Side (B), on a carpeted surface with the pre-drilled holes facing up as shown. Insert eight Minifix Cams (H1) into the Back Panel with the arrows of the cams facing out.

Insert 6 Minifix Cams (H1) into Sides with the arrow of the cams facing out.

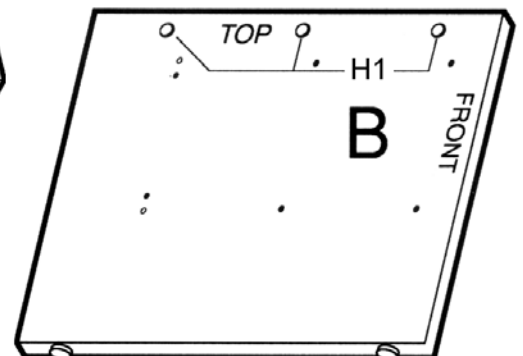
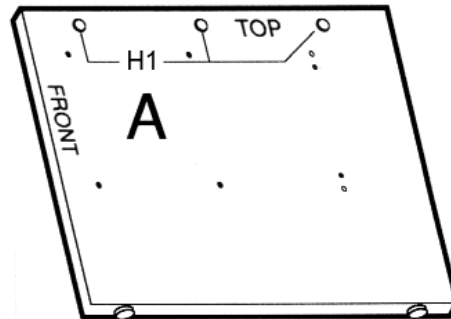
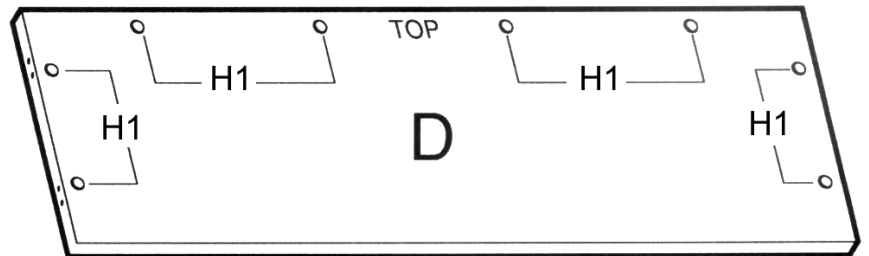

#2

Place the Left Side (A) and Right Side (B) on a clean carpeted surface with the pre-drilled holes facing up. Insert the Leveler Inserts (H1) into the holes in the bottom edges of each Side. Using a plastic mallet, tap until flush with the surface. Screw the Levelers (H2) into the Leveler Inserts.

Adjust Levelers when the assembled unit is in place.

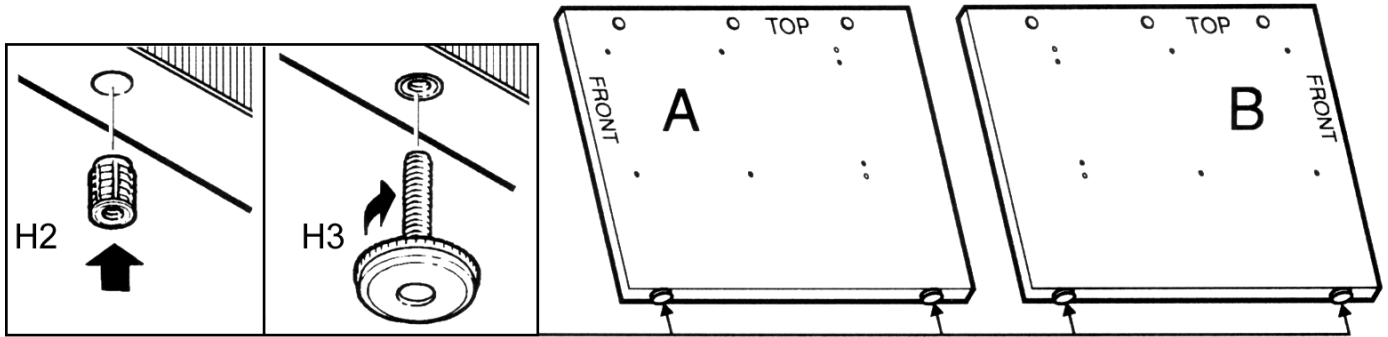
**#3**

Using a screwdriver, screw two Minifix Bolts (H4) into the Left Side Panel (A) where indicated. Repeat for Right Side Panel.

Insert two Wood Dowels (H5) into the Left Side Panel (A) where indicated.

Follow the same procedure for Right Side B.

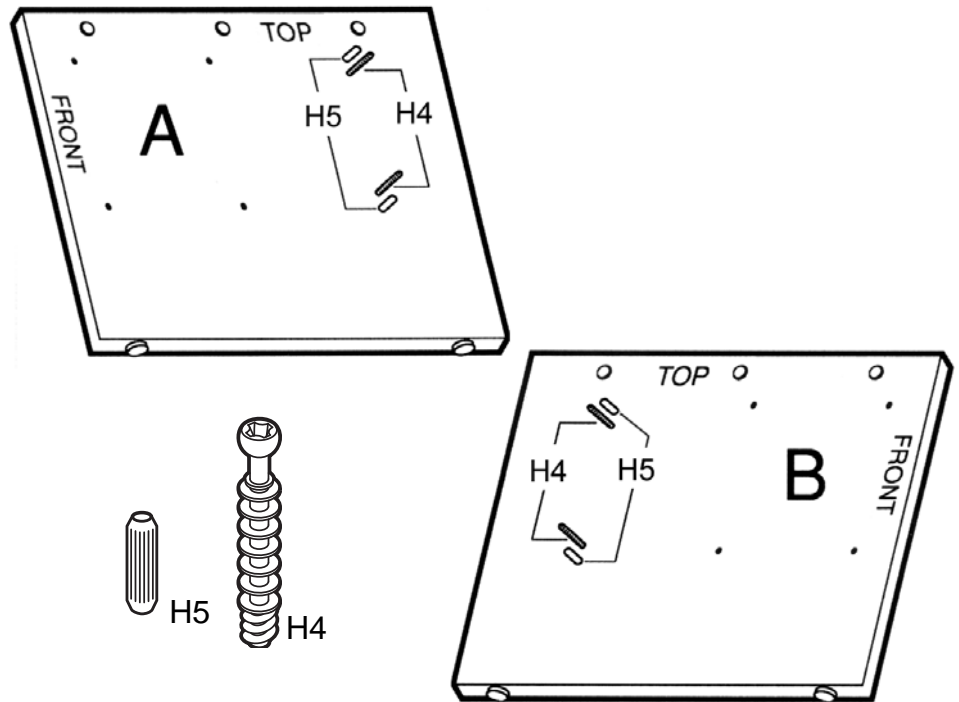
**#4**

Place the Top Panel (C) on a clean, carpeted surface as shown with the pre-drilled holes facing up. Using a screwdriver, screw ten Minifix Bolts (H4) into the Top Panel (C) where indicated.

Insert four Wood Dowels (H5) into the Top Panel (C) where indicated.

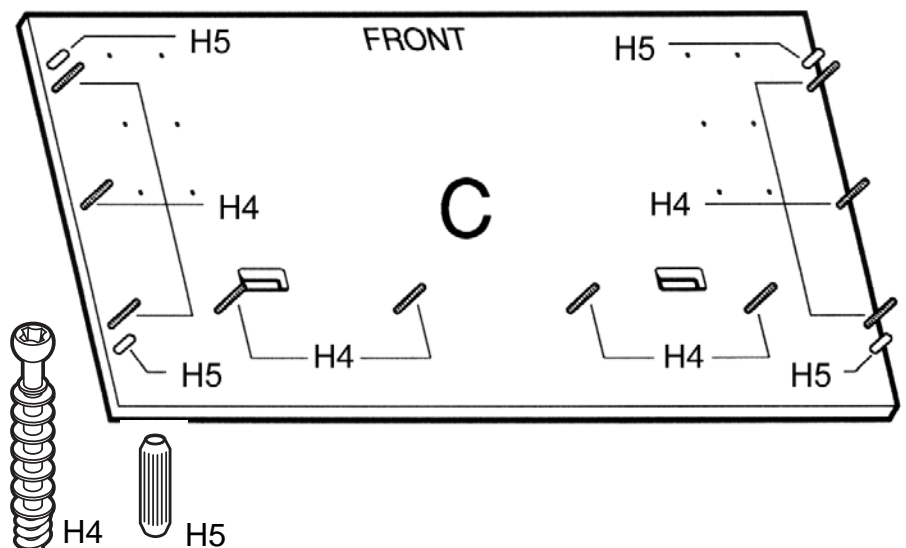

#5

Position the Left Side Panel (A) with the top edge down as shown. Position the Back Panel (D) onto the Left Side Panel (A) and turn the arrows of the indicated cams (H1) clockwise to secure.

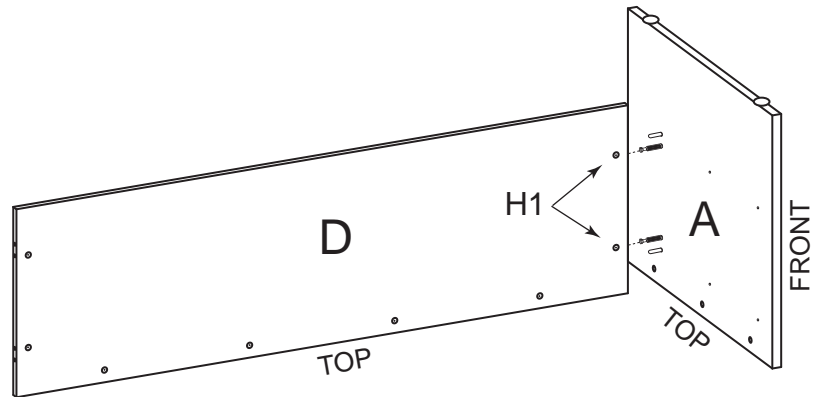

#6

Position the Right Side Panel (B) with the top edge down onto the Back Panel (D) as shown and turn the arrows of the indicated cams (H1) clockwise to secure.

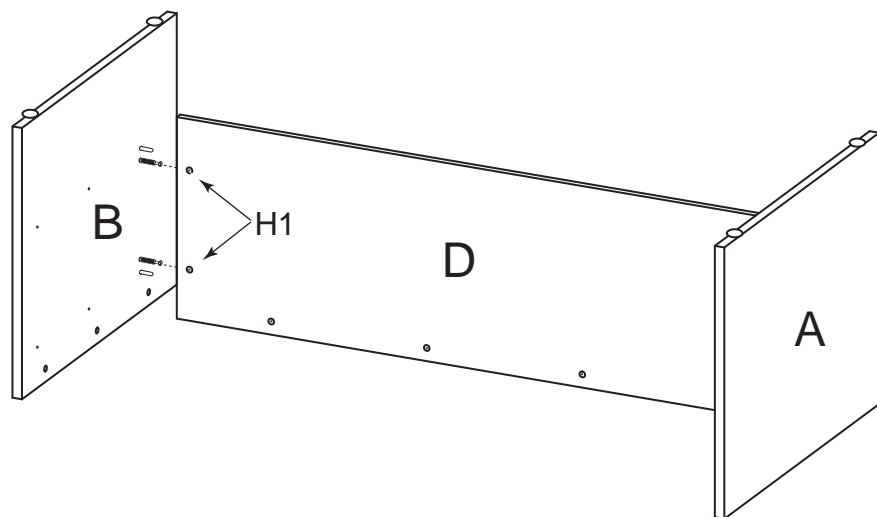

#7

Place the Top Panel (C) on a clean, carpeted surface with the bolts and dowels facing up as shown. With the assistance of another person, position the Side and Back Panel assembly (A, B & D) onto the Top Panel (C) as shown. Turn the arrows of the remaining cams (H1) on the Left Side Panel (A), Right Side Panel (B) and the Back Panel (D) clockwise to secure.

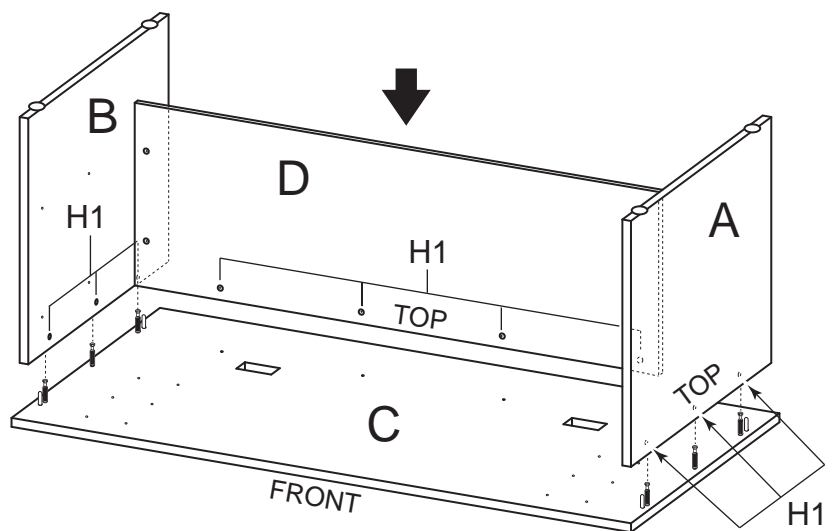

#8

With the assistance of another person, turn the unit upright. Insert Cable Grommets (H6) into the Top Panel (C) as shown.

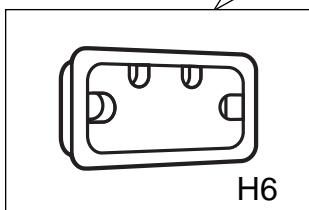
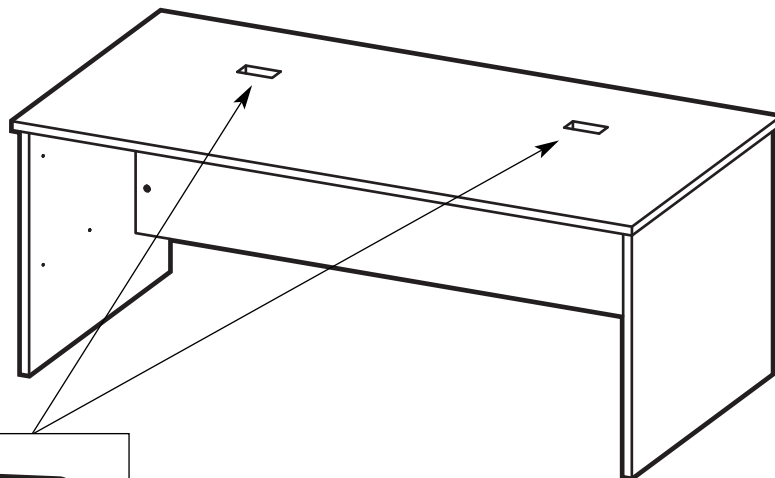

Your Glacier Library Desk is now assembled and ready for use.