



**IRONWOOD**

---

**SL**

---

**STANDING  
LECTERN**

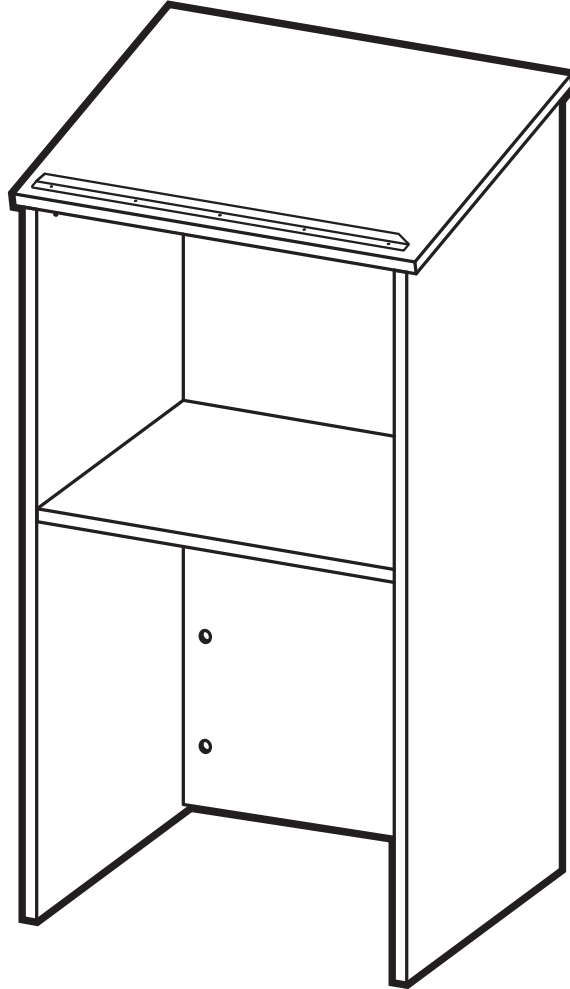

**IMPORTANT!**

**Assembly may require the assistance of another person.**

**Before you begin assembly:**

**READ THE DIRECTIONS** all the way through one time. This will speed up the process and help you understand the sequence of steps.

**COUNT THE PARTS AND HARDWARE** before assembly. This ensures you have received all necessary parts before you begin.

**TOOLS:** You may need a Phillips head screwdriver, a medium slotted screwdriver or a plastic mallet. To protect your new furniture from damage during assembly, it is recommended to work on a carpeted surface.

In the event any parts are missing from this package, send your name, address, telephone number, and a description of the missing part(s) to: **PARTS, Box 1420, Missoula, MT 59806** or call: **1-800-769-5693** or **FAX 1-800-445-5281**.

**CAUTION:** On assemblies requiring glue, make sure the unit is assembled correctly before gluing. Once this unit is assembled with glue, the manufacturer will not be responsible for damaged parts. Keep a damp cloth or sponge handy to wipe off excess glue.

To care for this furniture, simply wipe with a cloth dampened with glass cleaner containing ammonia-D.

## PARTS DIAGRAM

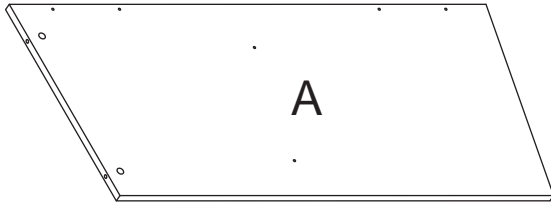

Left Side	05870441	1 ea.
-----------	----------	-------

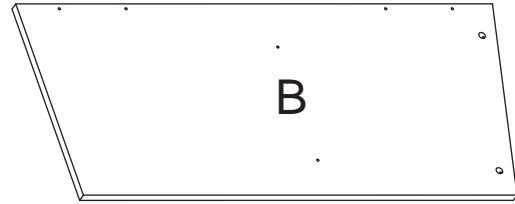

Right Side	05870441	1 ea.
------------	----------	-------

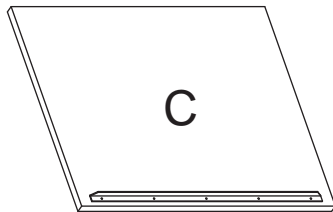

Top	05870101	1 ea.
-----	----------	-------

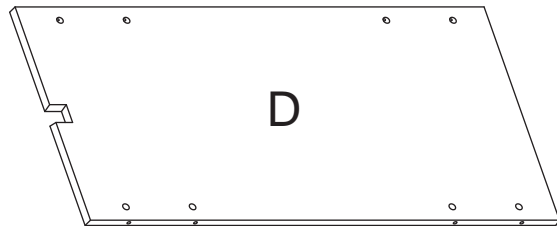

Back	05870452	1 ea.
------	----------	-------

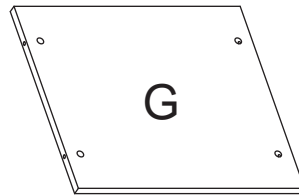

Shelf	05870427	1 ea.
-------	----------	-------

## HARDWARE



H1	Minifix Cam	909810	16 ea.
----	-------------	--------	--------



H3	Tack Glide	300865	4 ea.
----	------------	--------	-------



H2	Minifix Bolt	909834	16 ea.
----	--------------	--------	--------

### Using the Minifix System:

Insert the Minifix Cams into the appropriate holes with the arrow facing outwards as shown.

When screwing post into hole, **Do Not** over tighten. Screw post down until bottom face of post flange just touches board surface.

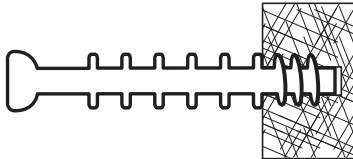

Using the #2 Phillips screwdriver, rotate the Cam Devices a half turn clockwise until snug.

To disassemble, turn the Cam Devices counter-clockwise and remove panels.

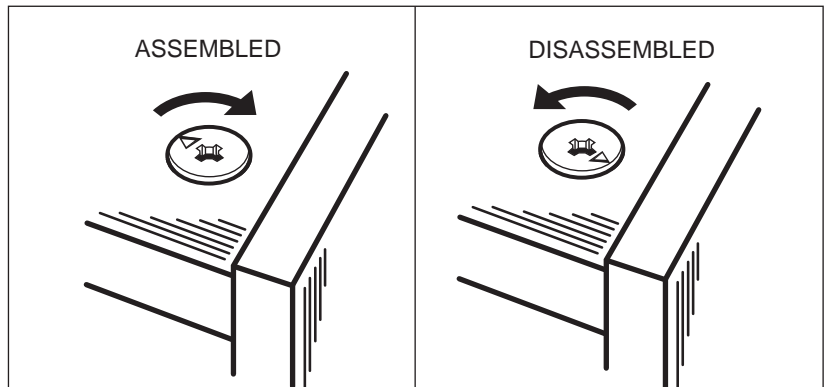
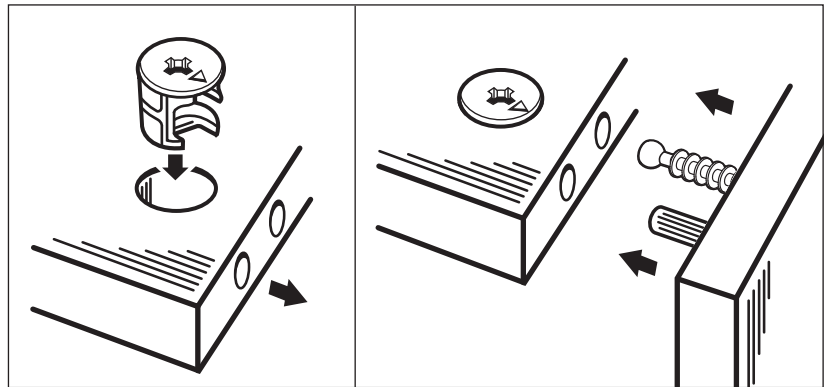

## #1

Place the Lectern Back (D) on a clean, carpeted surface or foam padding with the cam holes upright as shown. Insert eight Minifix Cams (E) into the Lectern Back where indicated with the arrows of the cams facing out.

Place Shelf (G) on a clean, carpeted surface or foam padding with the cam holes upright as shown. Insert four Minifix Cams (E) into the Shelf where indicated with the arrows of the cams facing out.

Place the Left Lectern side (A) and the Right Lectern Side (B) on a clean, carpeted surface or foam padding with the cam holes upright as shown. Insert Minifix Cams (E) into the Left Lectern side (A) and the Right Lectern Side (B) where indicated with the arrows of the cams facing out.

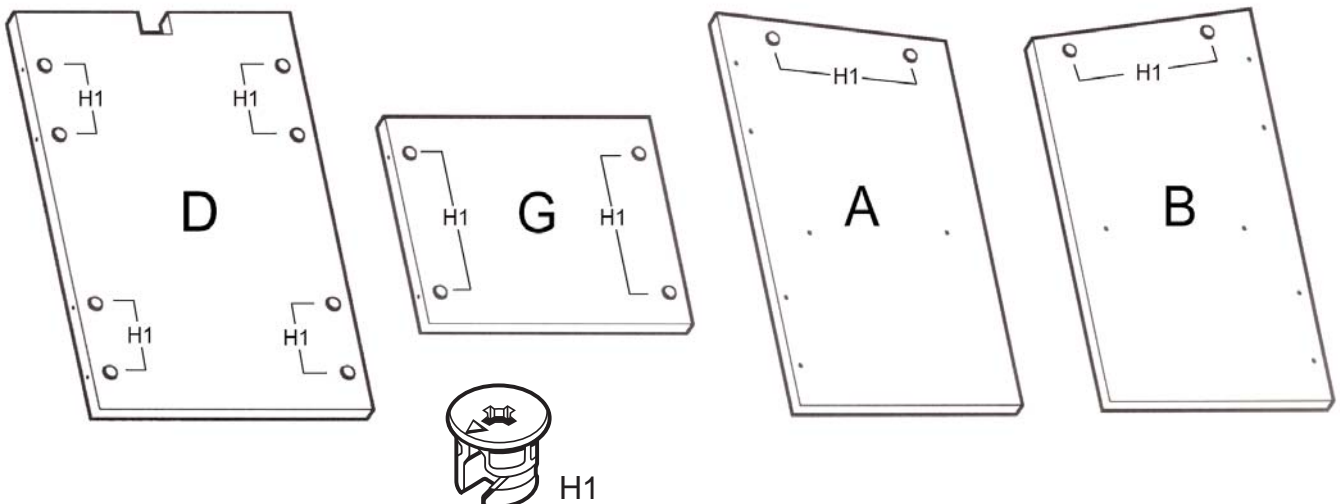

## #2

Screw Minifix Bolts (H2) into the Left Lectern side (A) and the Right Lectern Side (B) where indicated. Screw in Minifix Bolts where indicated on Top (C).

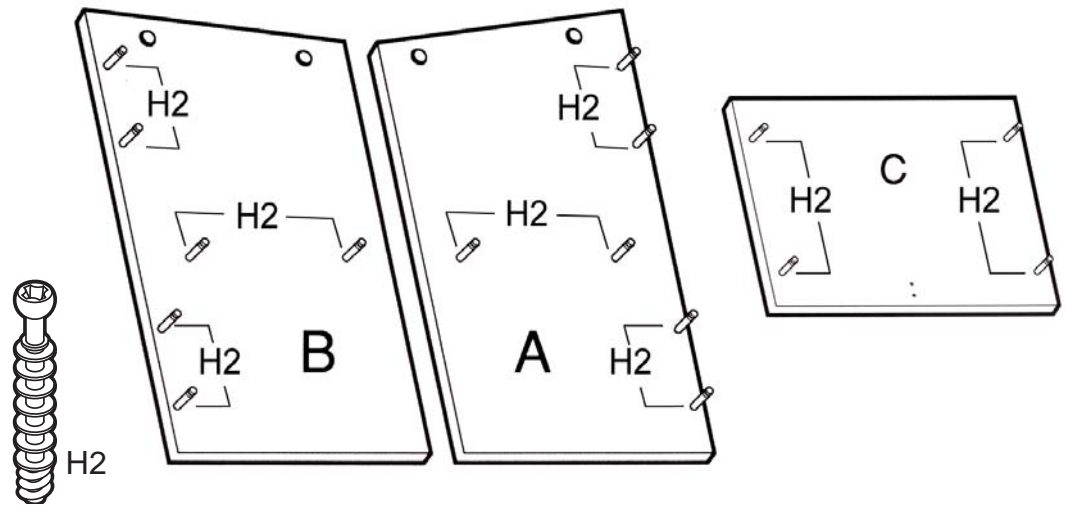

## #3

Position the Lectern Back (D) onto the Left Lectern Side (A) as shown. Turn the arrows of the Minifix cams (H1) clockwise to secure.

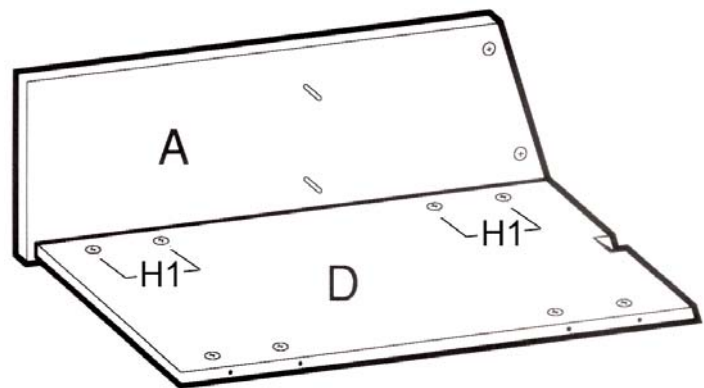

## #4

Position the Shelf (G) onto the Left Lectern Side (A) as shown. Turn the arrows of the Minifix cams (H1) clockwise to secure.

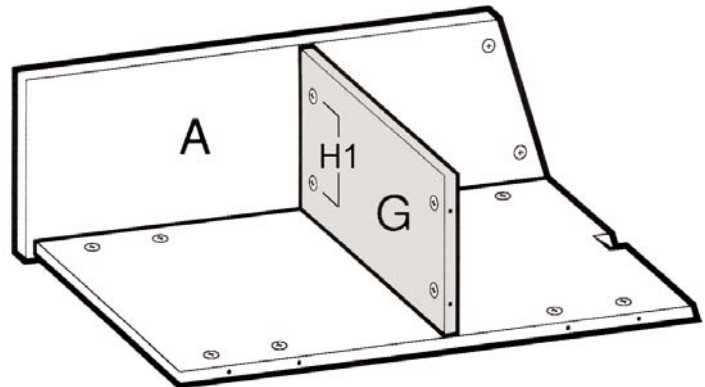

## #5

Position the Right Lectern Side (B) onto the Lectern Back (D) and Shelf (G) and turn the Cams (H1) clockwise to secure.

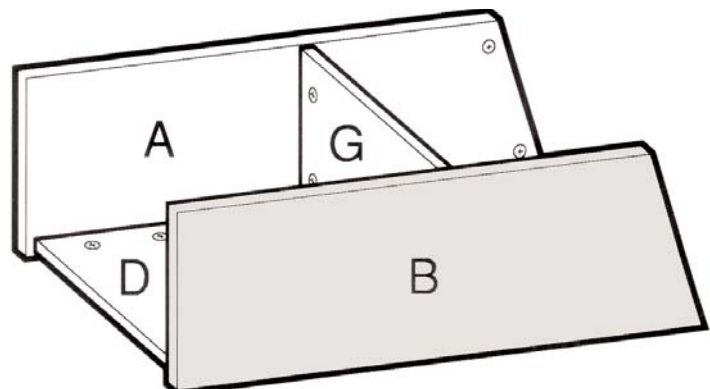

## #6

Position the bolts (H2) of the Lectern Top (C) into the corresponding holes of the Left Lectern Side (A) and the Right Lectern Side (B) and turn the Cams (H1) clockwise to secure in place.

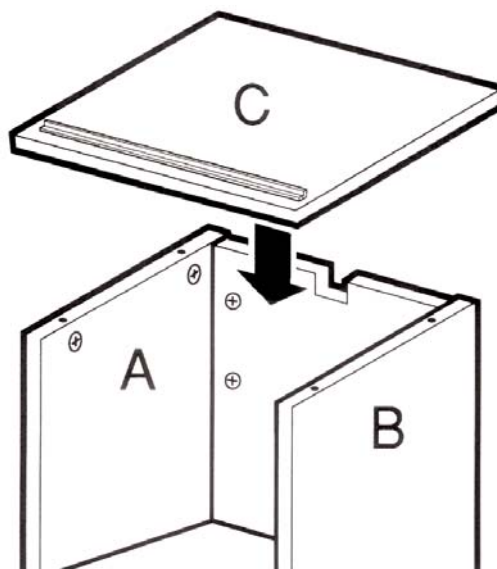

## #7

Tap the Tack Glides (H3) into the bottoms of the Sides as shown.

**NOTE:** You will have to measure for placement. There is no pre-drilled hole for the Tack Glide.

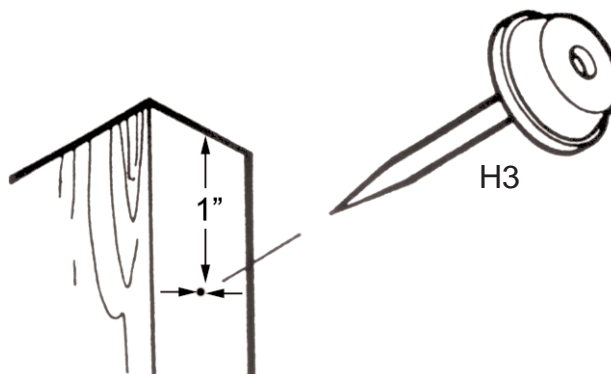

**Your Table Top Lectern is now fully assembled and ready for use.**

